

Corrugations on roof panels are not shown for clarity.

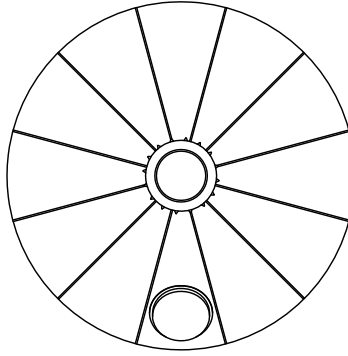

PLAN

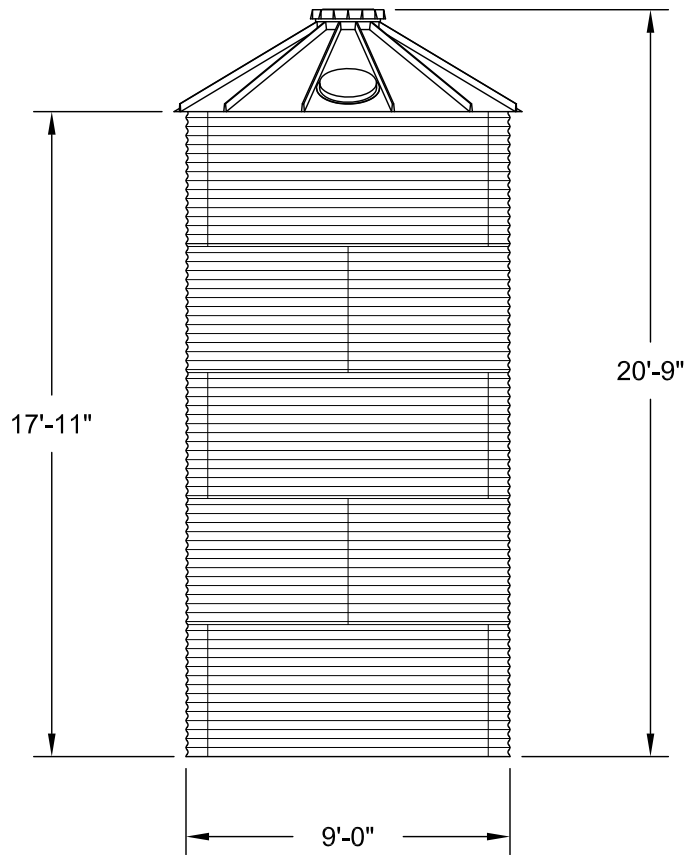

ELEVATION



WATER STORAGE TANKS, INC.
 1-800-463-1898
 www.corgaltanks.com

	BY	DATE
DWN	IU	2/15/13
CKD	JH	2/15/13
ENG	JH	2/15/13

TITLE	MODEL 0905-WT-CHR CORGAL STEEL WATER STORAGE TANK NOMINAL CAPACITY - 8,400 GALLONS (U.S.)	
DWG. NO.	0905-WT-CHR	REV. NO. C

THE DRAWING DEPICTED ON THIS PRINT AND THE INFORMATION CONTAINED HEREIN ARE PROPRIETARY TO Water Storage Tanks, Inc. AND SHALL NOT BE USED IN WHOLE OR PART WITHOUT THE WRITTEN CONSENT OF Water Storage Tanks, Inc.

SIZE A	SCALE 3/16"=1'-0"	SHEET 1 OF 1
-----------	----------------------	--------------------